

FEATURES

- * High current transfer ratio
(CTR : MIN. 100% at $I_F = 10\text{mA}$, $V_{CE} = 10\text{V}$)
- * Response time
(t_{on} : TYP. $3\mu\text{s}$ at $V_{CC} = 10\text{V}$, $I_C = 2\text{mA}$, $R_L = 100\Omega$)
- * Input-output isolation voltage
4N35 series : $V_{iso} = 3,550\text{Vrms}$
4N37 series : $V_{iso} = 1,500\text{Vrms}$
- * Dual-in-line package :
4N35, 4N37
- * Wide lead spacing package :
4N35M, 4N37M
- * Surface mounting package :
4N35S, 4N37S
- * Tape and reel packaging :
4N35S-TA1, 4N37S-TA1
- * UL approved (No. E113898)
- * TUV approved (No. R9653630)
- * DEMKO approved (No. 303985)

OUTLINE DIMENSIONS

4N35 :

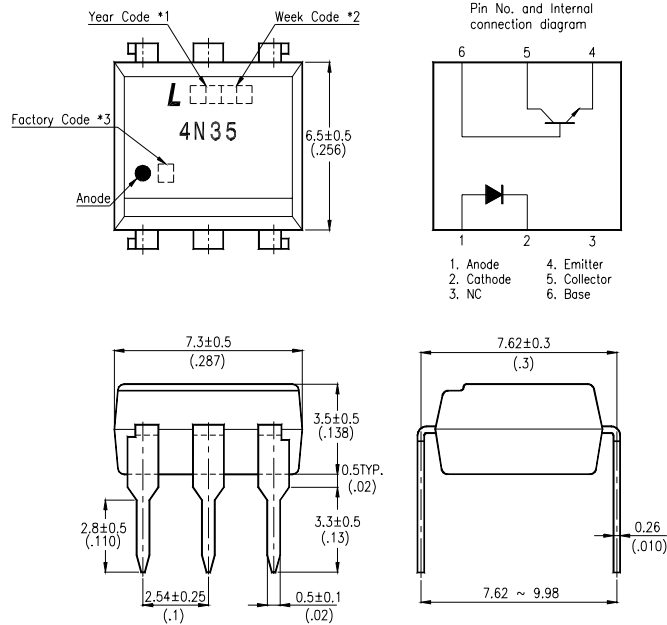

4N37 :

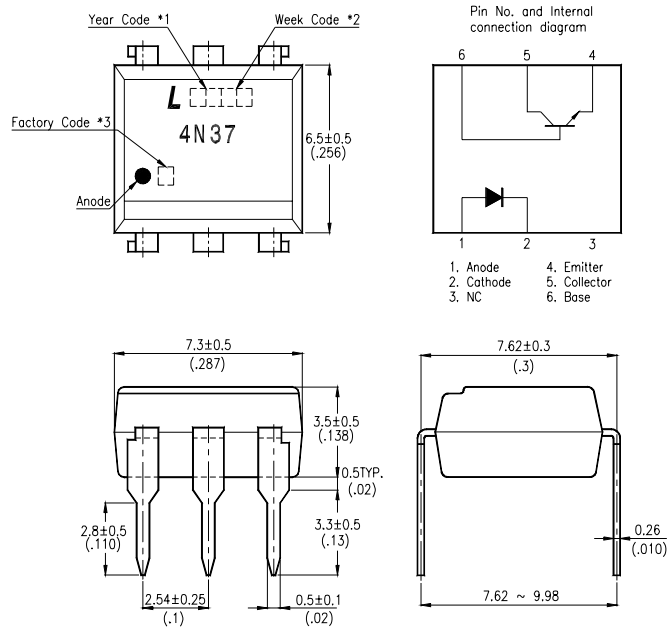

*1. Year date code.

*2. 2-digit work week.

*3. Factory identification mark shall be marked (Z : Taiwan, Y : Thailand, X : China).

OUTLINE DIMENSIONS

4N35M :

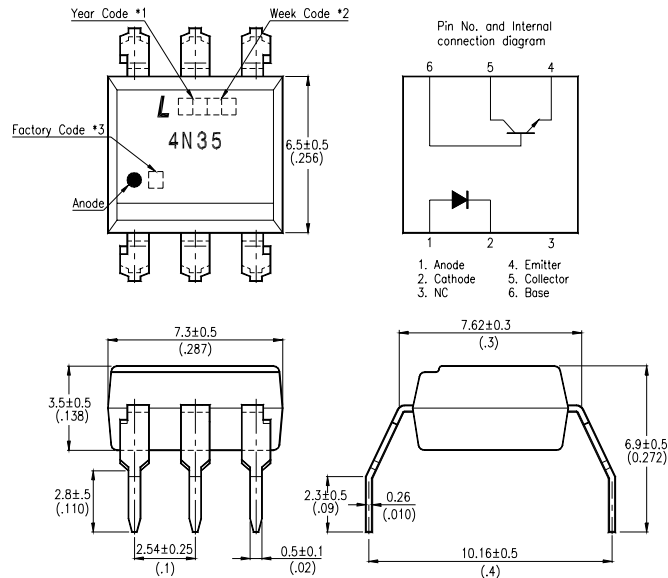

4N37M :

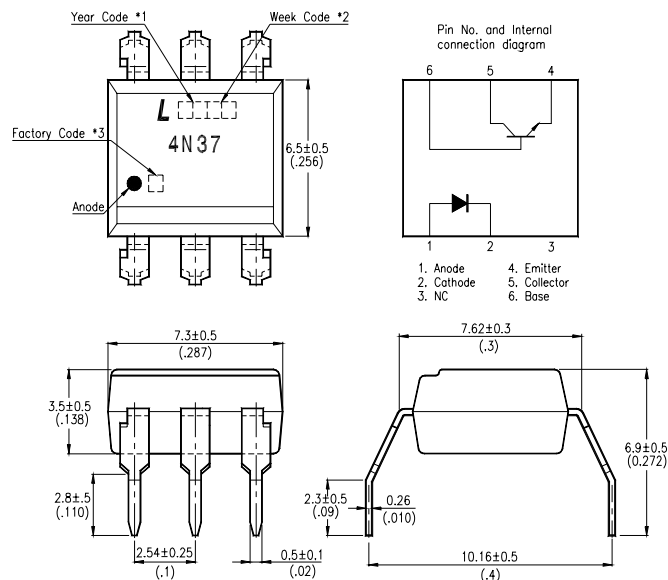

*1. Year date code.

*2. 2-digit work week.

*3. Factory identification mark shall be marked (Z : Taiwan, Y : Thailand, X : China).

OUTLINE DIMENSIONS

4N35S :

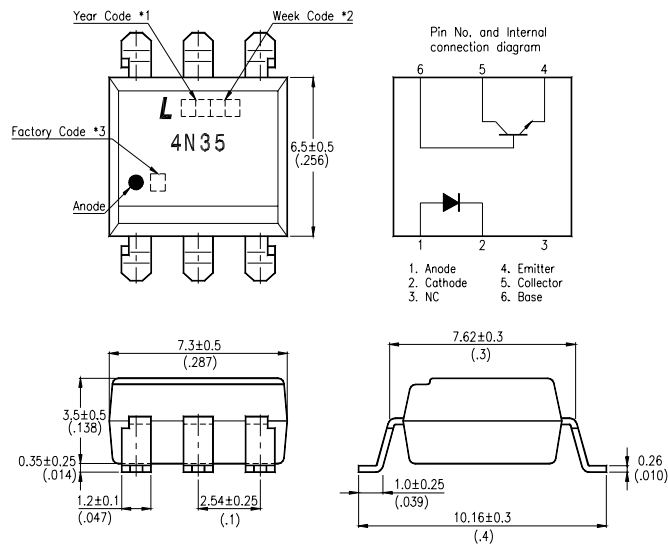

4N37S :

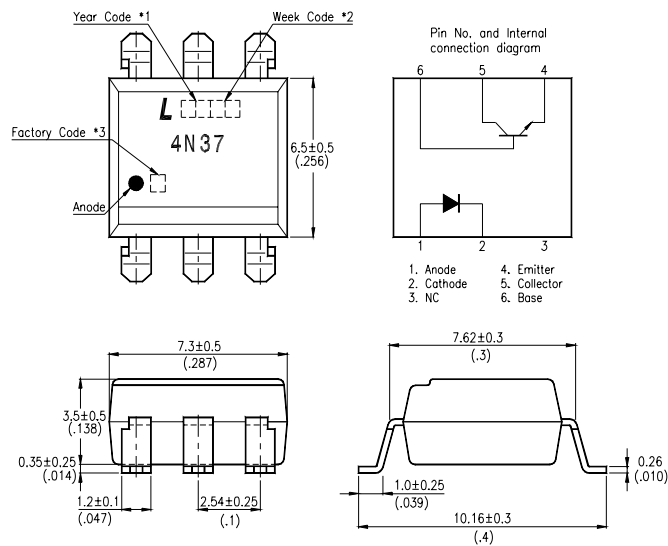

*1. Year date code.

*2. 2-digit work week.

*3. Factory identification mark shall be marked (Z : Taiwan, Y : Thailand, X : China).

TAPING DIMENSIONS

4N35S-TA1 , 4N37S-TA1 :

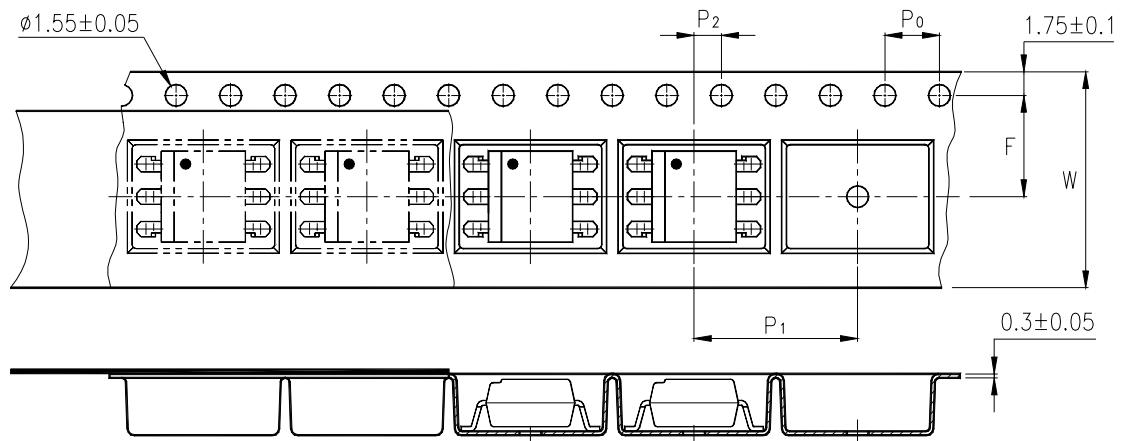

Description	Symbol	Dimensions in mm (inches)
Tape wide	W	16 ± 0.3 (.63)
Pitch of sprocket holes	P_0	4 ± 0.1 (.15)
Distance of compartment	F	7.5 ± 0.1 (.295)
Distance of compartment to compartment	P_2	2 ± 0.1 (.079)
Distance of compartment to compartment	P_1	12 ± 0.1 (.472)

ABSOLUTE MAXIMUM RATING

(Ta = 25°C)

PARAMETER		SYMBOL	RATING	UNIT
INPUT	Forward Current	I _F	60	mA
	Reverse Voltage	V _R	6	V
	Power Dissipation	P	100	mW
OUTPUT	Collector - Emitter Voltage	V _{CEO}	30	V
	Emitter - Collector Voltage	V _{ECO}	7	V
	Collector - Base Voltage	V _{CBO}	70	V
	Collector Current	I _C	100	mA
	Collector Power Dissipation	P _C	300	mW
Total Power Dissipation		P _{tot}	350	mW
*1 Isolation Voltage	4N35 series	V _{iso}	3,550	V _{rms}
	4N37 series		1,500	
Operating Temperature		T _{opr}	-55 ~ +100	°C
Storage Temperature		T _{stg}	-55 ~ +150	°C
*2 Soldering Temperature		T _{sol}	260	°C

*1. AC For 1 Minute, R.H. = 40 ~ 60%

Isolation voltage shall be measured using the following method.

- (1) Short between anode and cathode on the primary side and between collector, emitter and base on the secondary side.
- (2) The isolation voltage tester with zero-cross circuit shall be used.
- (3) The waveform of applied voltage shall be a sine wave.

*2. For 10 Seconds

ELECTRICAL - OPTICAL CHARACTERISTICS

(Ta = 25°C)

PARAMETER		SYMBOL	MIN.	TYP.	MAX.	UNIT	CONDITIONS	
INPUT	Forward Voltage	V _F	—	1.2	1.5	V	I _F =10mA	
	Reverse Current	I _R	—	—	10	μA	V _R =4V	
	Terminal Capacitance	C _t	—	50	—	pF	V=0, f=1KHz	
OUTPUT	Collector Dark Current	I _{CEO}	Ta=25°C	—	—	50	nA	V _{CE} =10V, I _F =0
			Ta=100°C	—	—	500	μA	V _{CE} =30V, I _F =0
	Collector-Emitter Breakdown Voltage	BV _{CEO}	30	—	—	V	I _C =0.1mA I _F =0	
	Emitter-Collector Breakdown Voltage	BV _{ECO}	7	—	—	V	I _E =10μA I _F =0	
	Collector-Base Breakdown Voltage	BV _{CBO}	70	—	—	V	I _C =0.1mA I _F =0	
TRANSFER CHARACTERISTICS	Collector Current	I _C	10	—	—	mA	I _F =10mA V _{CE} =10V	
	* Current Transfer Ratio	CTR	100	—	—	%		
	Collector-Emitter Saturation Voltage	V _{CE(sat)}	—	—	0.3	V	I _F =50mA I _C =2mA	
	Isolation Resistance	R _{iso}	5×10 ¹⁰	1×10 ¹¹	—	Ω	DC500V 40 ~ 60% R.H.	
	Floating Capacitance	C _f	—	1	2.5	pF	V=0, f=1MHz	
	Response Time (Turn-on)	t _{on}	—	3	10	μs	V _{CC} =10V, I _C =2mA R _L =100Ω	
	Response Time (Turn-off)	t _{off}	—	3	10	μs		

$$* \text{ CTR} = \frac{I_C}{I_F} \times 100\%$$

CHARACTERISTICS CURVES

Fig.1 Forward Current vs. Ambient Temperature

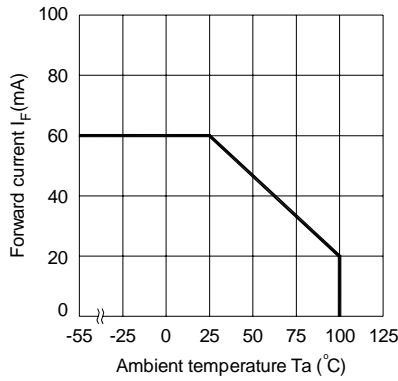

Fig.2 Collector Power Dissipation vs. Ambient Temperature

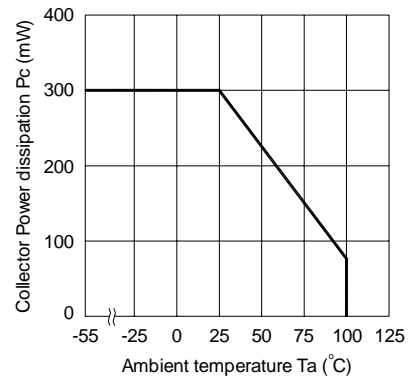

Fig.3 Forward Current vs. Forward Voltage

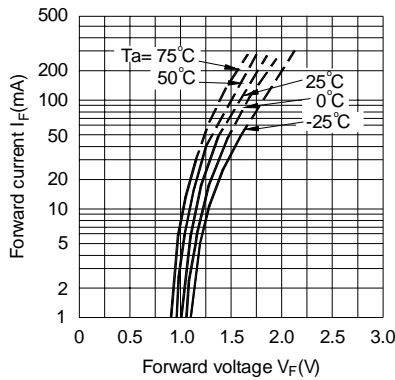

Fig.4 Current Transfer Ratio vs. Forward Current

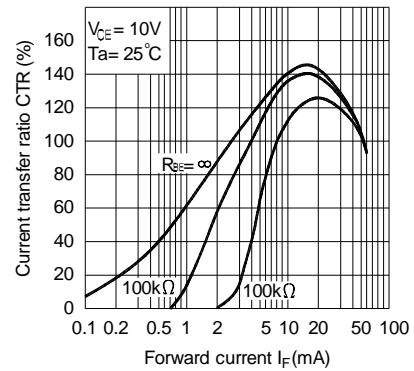

Fig.5 Collector Current vs. Collector-emitter Voltage

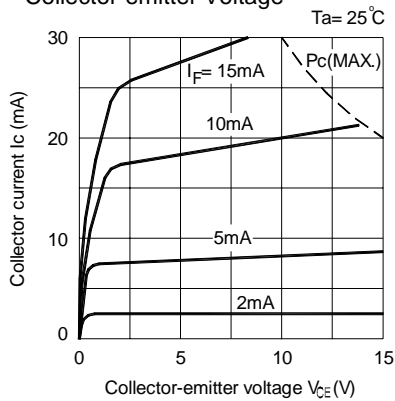
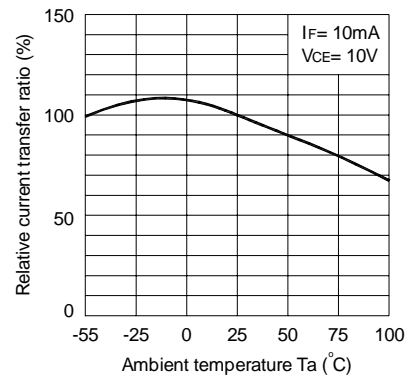

Fig.6 Relative Current Transfer Ratio vs. Ambient Temperature



CHARACTERISTICS CURVES

Fig.7 Collector-emitter Saturation Voltage vs. Ambient Temperature

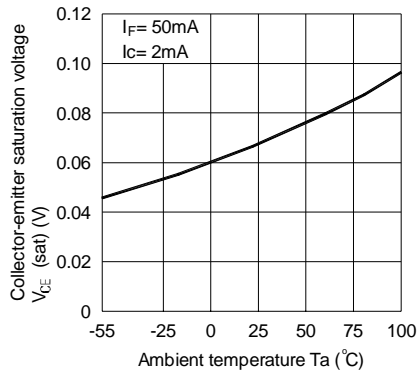

Fig.8 Collector Dark Current vs. Ambient Temperature

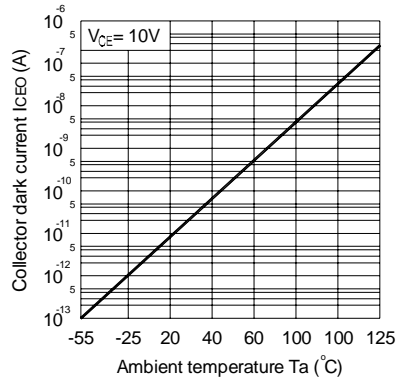

Fig.9 Response Time vs. Load Resistance

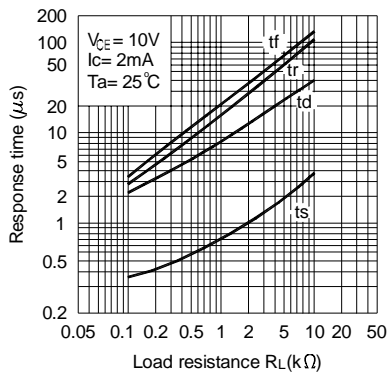

Fig.10 Frequency Response

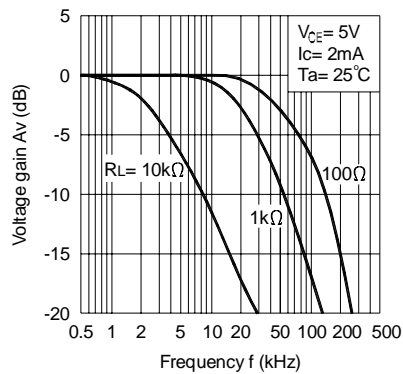
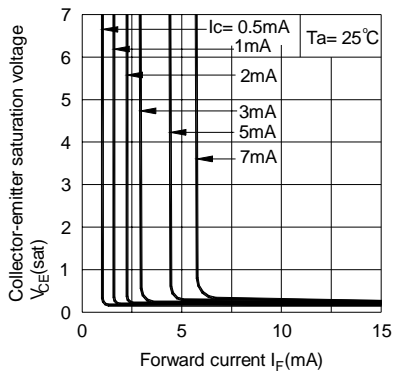
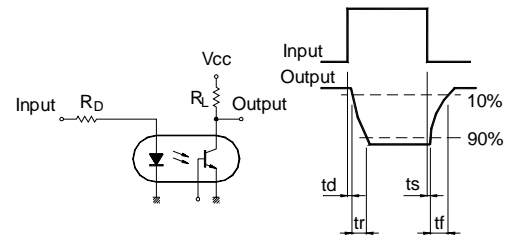

Fig.11 Collector-emitter Saturation Voltage vs. Forward Current



Test Circuit for Response Time



Test Circuit for Frequency Response

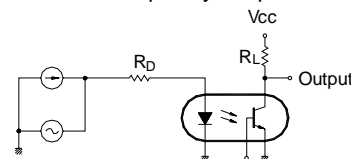

RECOMMENDED FOOT PRINT PATTERNS (MOUNT PAD)

Unit : mm

